

Area and Perimeter of L Shapes

Find the area and perimeter of each shape.

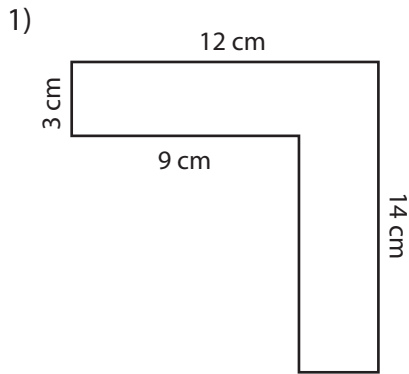

Area: _____
Perimeter: _____

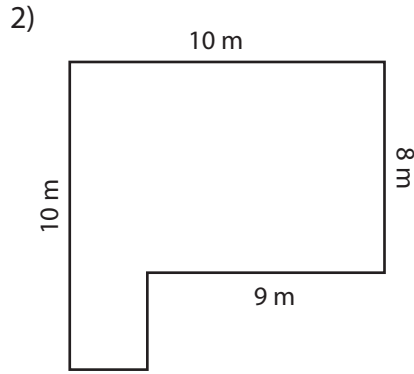

Area: _____
Perimeter: _____

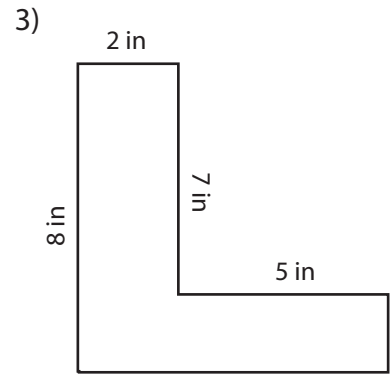

Area: _____
Perimeter: _____

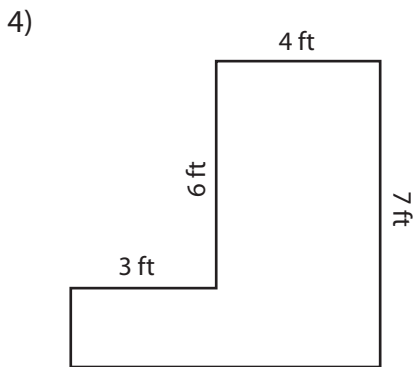

Area: _____
Perimeter: _____

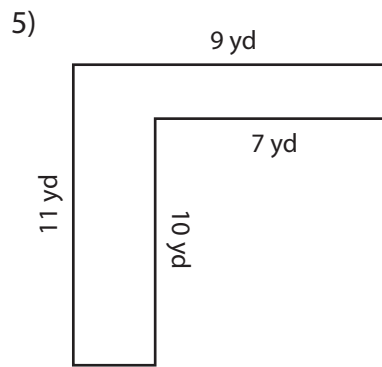

Area: _____
Perimeter: _____

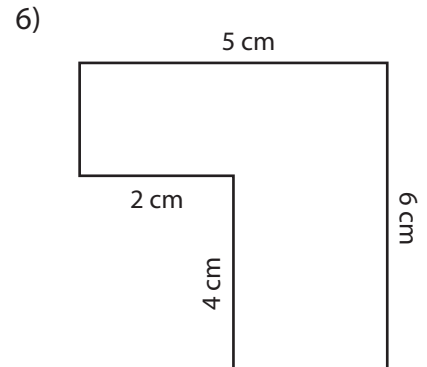

Area: _____
Perimeter: _____

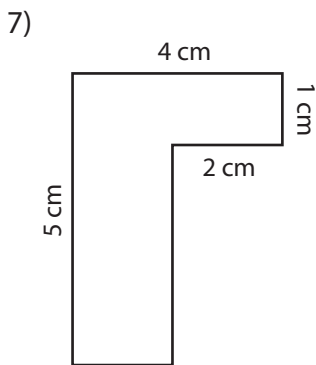

Area: _____
Perimeter: _____

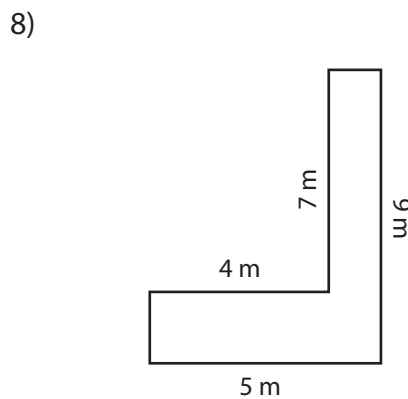

Area: _____
Perimeter: _____

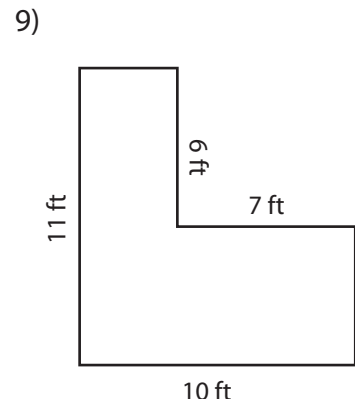

Area: _____
Perimeter: _____

Answer key

Find the area and perimeter of each shape.

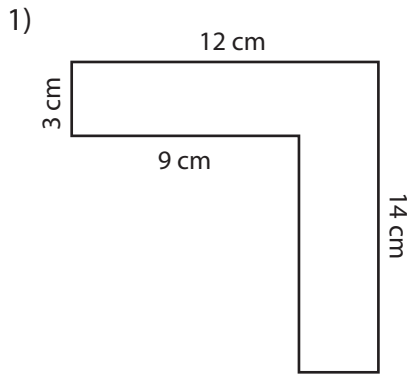

Area: **69 cm²**
 Perimeter: **52 cm**

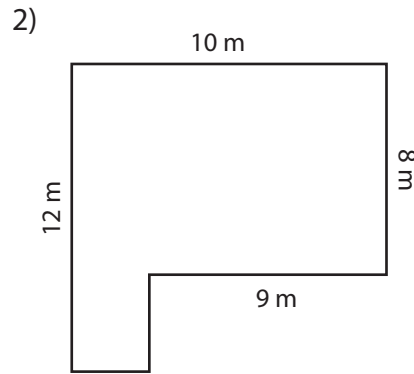

Area: **84 m²**
 Perimeter: **44 m**

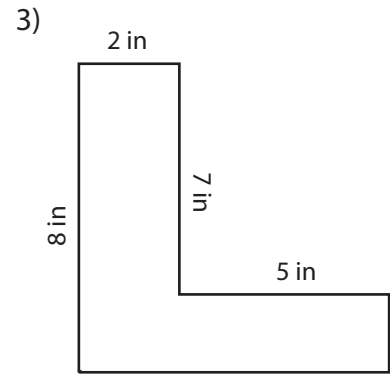

Area: **21 in²**
 Perimeter: **30 in**

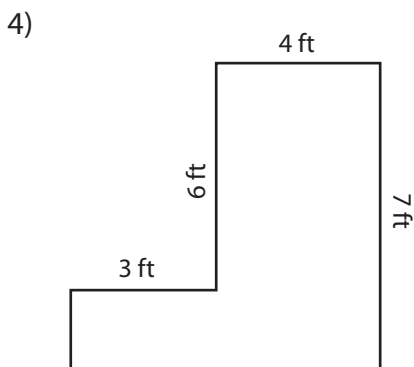

Area: **31 ft²**
 Perimeter: **28 ft**

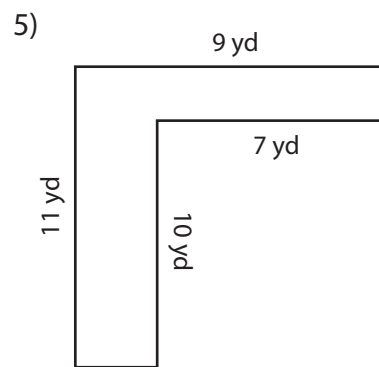

Area: **29 yd²**
 Perimeter: **40 yd**

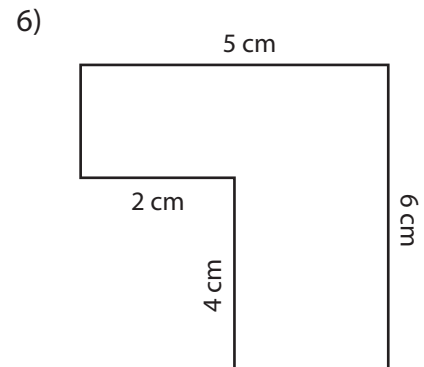

Area: **22 cm²**
 Perimeter: **22 cm**

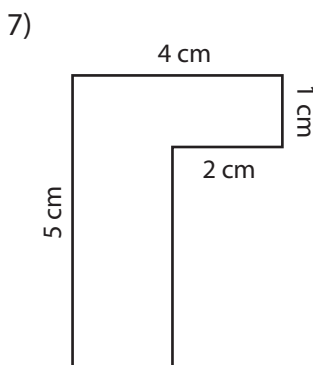

Area: **12 cm²**
 Perimeter: **18 cm**

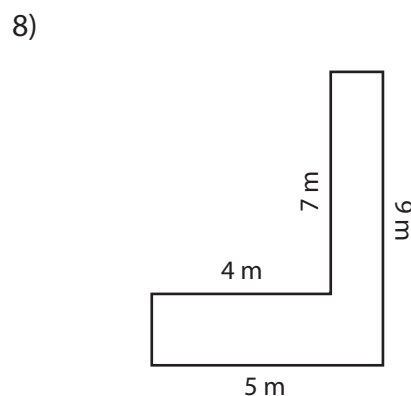

Area: **17 m²**
 Perimeter: **28 m**

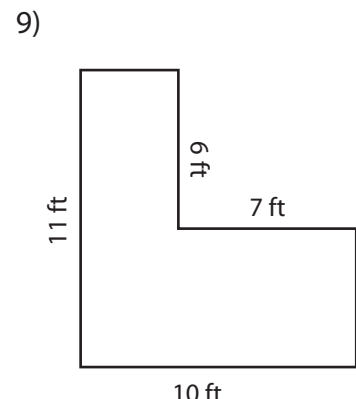

Area: **68 ft²**
 Perimeter: **42 ft**